

# CLASSE

Owner's Manual  
CP-800  
Stereo Preamp/Processor

# NOTICE

All of us at Classé take extreme care to ensure that your purchase will remain a prized investment. We are proud to inform you that all Classé components have been officially approved for the European Community (CE) mark.

This means that your Classé product was subjected to the most rigorous manufacturing and safety tests in the world. The CE mark certifies that your purchase meets or exceeds all European Community requirements for manufacturing consistency and consumer safety.

This equipment has been tested and found to comply with the limits for a Class B digital device, pursuant to Part 15 of the FCC Rules. Operation is subject to the following two conditions: (1) This device may not cause harmful interference, and (2) This device must accept any interference received, including interference that may cause undesired operation. These limits are designed to provide reasonable protection against harmful interference in a residential installation. This equipment generates, uses and can radiate radio frequency energy and, if not installed and used in accordance with the instructions, may cause harmful interference to radio communications. However, there is no guarantee that interference will not occur in a particular installation. If this equipment does cause interference to radio or television reception, which can be determined by turning the equipment on and off, the user is encouraged to try to correct the interference by one or more of the following measures:

- Reorient or relocate the receiving antenna;
- Increase the separation between the equipment and the receiver;
- Connect the equipment into an outlet on a circuit different from that to which the receiver is connected;
- Consult the dealer or an experienced radio/TV technician for help.

**CAUTION:** Changes or modifications to this equipment not expressly approved by the manufacturer could void the user's authority to operate the equipment.

This product incorporates copyright protection technology that is protected by U.S. patents and other intellectual property rights. Reverse engineering or disassembly is prohibited.

The information contained in the manual is subject to change without notice. The most current version of this manual will be posted on our web site at <http://www.classeaudio.com>.



Classé marks the "CE" symbol indicating compliance of this device with the EMC (Electromagnetic Compatibility) and LVD (Low Voltage Directive) standards of the European Community.



Classé complies with the European Parliament and Council Directive 2002/96/EC concerning Waste Electrical and Electronic Equipment (WEEE). This product must be appropriately recycled or processed in accordance with these directives. Consult your local waste disposal authority for guidance.



Classé products are designed and manufactured to comply with the Restriction of Hazardous Substances (RoHS) as stated in the European Parliament and Council Directive 2002/95/EC.

# Important Safety Instructions

1. Read these instructions.
2. Keep these instructions.
3. Heed all warnings.
4. Follow all instructions.
5. Do not use this apparatus near water.
6. Clean only with dry cloth.
7. Do not block any ventilation openings. Install in accordance with the manufacturer's instructions.
8. Do not install near any heat sources such as radiators, heat registers, stoves, or other apparatus (including amplifiers) that produce heat.
9. Do not defeat the safety purpose of the polarized or grounding-type plug. A polarized plug has two blades with one wider than the other. A grounding type plug has two blades and a third grounding prong. The wide blade or the third prong are provided for your safety. If the provided plug does not fit into your outlet, consult an electrician for replacement of the obsolete outlet.
10. Protect the power cord from being walked on or pinched particularly at plugs, convenience receptacles, and the point where they exit from the apparatus.
11. Only use attachments/accessories specified by the manufacturer.
12.  Use only with the cart, stand, tripod, bracket, or table specified by the manufacturer, or sold with the apparatus. When a cart is used, use caution when moving the cart/apparatus combination to avoid injury from tip-over.
13. Unplug this apparatus during lightning storms or when unused for long periods of time.
14. Refer all servicing to qualified service personnel. Servicing is required when the apparatus has been damaged in any way, such as power-supply cord or plug is damaged, liquid has been spilled or objects have fallen into the apparatus, the apparatus has been exposed to rain or moisture, does not operate normally, or has been dropped.
15. Do not expose this apparatus to dripping or splashing and ensure that no objects filled with liquids, such as vases, are placed on the apparatus.
16. To completely disconnect this apparatus from the AC Mains, disconnect the power supply cord plug from the AC receptacle.
17. The mains plug of the power supply cord shall remain readily operable.
18. Do not expose batteries to excessive heat such as sunshine, fire or the like.

**WARNING: TO REDUCE THE RISK OF FIRE OR ELECTRIC SHOCK,  
DO NOT EXPOSE THIS APPLIANCE TO RAIN OR MOISTURE.**

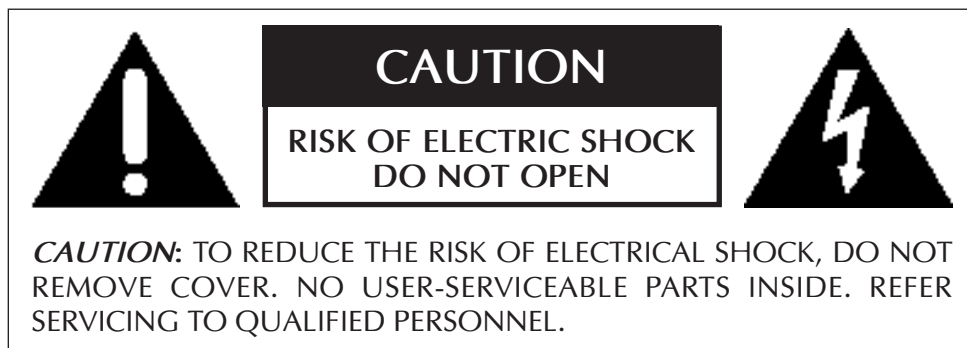

The lightning flash with arrowhead symbol within an equilateral triangle is intended to alert the user to the presence of uninsulated “dangerous voltage “ within the product’s enclosure that may be of sufficient magnitude to constitute a risk of electric shock to persons.



The exclamation point within an equilateral triangle is intended to alert the user to the presence of important operating and maintenance (servicing) instructions in the literature accompanying the product.

# Contents

Introduction .....	6
Exceptional Design Features .....	7
versatile connectivity.....	7
superior performance .....	7
clean, dedicated power .....	7
room equalization and speaker control .....	7
flexible GUI.....	7
extraordinary longevity.....	7
Unpacking and Placement.....	8
unpacking your CP-800.....	8
CP-800 placement considerations .....	8
warm-up/break-in period.....	9
operating voltage.....	9
Front Panel.....	10
Rear Panel.....	13
serial number .....	13
The Remote Control.....	17
Initial Setup.....	19
Using the CP-800.....	22
source selection.....	22
The Menu System .....	24
System Setup.....	24
Source Setup .....	25
Enable Source .....	25
Input Connector.....	25
Source Name .....	26
Configuration.....	26
Input Offset.....	26
Pass-Thru .....	26
Analog Bypass .....	26
Configuration Setup.....	27
Configuration Name .....	27
Configure Outputs .....	27
Auxiliary Channels.....	28
Display Setup .....	28
Brightness .....	28
Timeout.....	29
Volume Setup .....	29
Max Volume .....	30
Startup Volume .....	30
Mute Setup.....	31
EQ Setup .....	31
Tone Control Setup.....	32
Teach IR .....	32
Remote Fkeys .....	33
DC Triggers.....	34
Tone Control.....	34
Balance .....	35
Configurations.....	35
Mono.....	35
Status.....	35
CAN-Bus .....	36
features .....	36

hardware setup .....	36
using CAN-Bus.....	37
CAN-Bus shared features .....	38
configuration .....	38
operate .....	38
AC status .....	38
CAN-Bus model specific features .....	38
PlayLink .....	38
amp info .....	39
event log.....	39
Troubleshooting .....	40
Care & Maintenance .....	42
Specifications.....	43
Dimensions.....	45
Installation Worksheet.....	46

# Introduction

## Welcome to the Classé family!

Congratulations on your purchase of the Classé CP-800, a next-generation stereo preamp/processor with reference-quality performance. We are sure that you will enjoy it for many years to come.

Classé values its relationships with our customers and intend on supplying the highest level of support along with our product. Registering your product will allow us to keep in touch and will ensure that you are notified regarding any future updates or options which become available. Furthermore, in the unlikely event that your product needs service support, a product that is already registered doesn't need your original sales slip for proof of warranty.

You can register online at [www.classeaudio.com](http://www.classeaudio.com) or complete and mail the registration card located in the separate warranty booklet.

---

**Please take a few moments now to register your new Classé processor and record your serial number here for future reference.**

**Serial #:** \_\_\_\_\_

---

*Please note that your Classé warranty is valid only in the country of purchase. Alternatively, units may be returned to Classe in Canada for warranty service.*

# Exceptional Design Features

The CP-800 is a next-generation stereo preamp/processor, designed for music lovers who demand the ultimate in sonic performance from their audio system. Its connectivity and processing power accommodate the ever increasing array of music sources, allowing them to be accessed and enjoyed without compromise.

versatile connectivity

The CP-800 is a stereo preamp/processor with both balanced and single-ended connections for all channels. A comprehensive set of analog and digital inputs and control interfaces enable compatibility with most contemporary audio system equipment.

superior performance

Advanced circuit topologies, component parts, and circuit layout techniques combine for superior audio performance. The analog and digital signal paths have been optimized to ensure superior performance from every source.

clean, dedicated power

A newly developed switch mode power supply employing PFC (Power Factor Correction) provides the clean, high-current power required for best performance. With PFC, the CP-800 operates at maximum efficiency without disturbing other audio components sharing the same AC mains.

room equalization  
and speaker control

All home audio systems are affected by room characteristics. Sound reflections and sound absorption can create dramatic variations in the performance of your system, particularly in the lower frequencies. The CP-800 features a system of filters which, in the hands of an experienced acoustician, can help optimize the performance of your system.

flexible GUI

The front panel's LCD touchscreen supports an extremely flexible and versatile graphical user interface (GUI) while maintaining a clean, uncluttered appearance. The CP-800 provides a range of controls that might otherwise require dozens of buttons and knobs on the front panel. Despite this power and flexibility, it remains simple to operate in day-to-day use.

extraordinary longevity

Because Classé has developed highly refined circuits over many years, we have vast experience in what works well over the long term. Using this knowledge base, along with quantitative results derived from highly accelerated life testing (H.A.L.T.) allows us to select only the most reliable parts. This attention to detail and design allows us to manufacture products which stand the ultimate test: time.

Just as past Classé products have done for their owners, we are certain that your new Stereo Preamp/Processor will give you many years of continuous enjoyment.

# Unpacking and Placement

We have taken all precautions, and made every effort to make the CP-800 simple and straightforward to install and use. Still, we recommend that you take a few minutes to review this manual. Even if you are having the preamp/processor professionally installed, you will want to know how to efficiently operate it to its potential.

The CP-800 menu system includes features that provide you with a great deal of fine-tuning. Still, we have no way to evaluate outside variables such as the acoustical characteristics of your listening space and the associated equipment of your audio system. Therefore, it is up to you to make the final audio adjustments for the optimum performance of your system.

*For this reason, we strongly encourage you to have your preamp/processor installed and calibrated by your dealer. The experience, training, and specialized equipment they have can make a profound difference in the final performance of your system.*

unpacking your CP-800

Carefully unpack the CP-800 Stereo Preamp/Processor according to the supplied instruction sheet. *Do not forget to remove all accessories from the carton.*



**Important!**

---

**Keep all packing materials. Transporting the CP-800 without using the packaging specifically designed for it may result in damage that is not covered under the warranty.**

---

CP-800 placement considerations

Before installing your CP-800, be sure to read the following placement suggestions.

- Do not place the CP-800 directly on the top surface of a conventional power amplifier or any other heat source. Also keep the unit out of direct sunlight.
- Place the CP-800 so that the IR window on the front panel is clearly visible and not blocked.
- Position the CP-800 in a central and convenient location for both visibility and use. The preamp/processor is the hub for all other component connections and generally your primary interaction point. In addition, by placing the unit close to the other system components, you minimize the cable lengths and hence reduce the amount of noise that is introduced into the system through the cabling.
- Leave adequate clearance behind the CP-800 for the AC cord and connecting cables. We suggest six inches (15 cm) of free space to allow cables sufficient room to bend without crimping or undue strain.
- Allow at least three inches (7.5 cm) of clearance above and to each side of the CP-800 for ventilation. Do not obstruct the area around the unit so that excess heat can dissipate through normal air circulation.



**Important!**

---

**Obey all placement considerations. Not obeying the placement considerations may result in damage that is not covered under the warranty.**

---

warm-up/break-in period

Your new Classé preamp/processor delivers outstanding performance immediately. However, you can expect to hear subtle improvements as it reaches normal operating temperatures and breaks-in.

In our experience, you can expect the greatest changes within the first 72 hours. After initial break-in, you'll enjoy consistent performance levels for years to come.

operating voltage

The operating voltage of your CP-800 is 100-240 V, 50/60 Hz.



**Important!**

---

**Attempting to operate your CP-800 from an incorrect AC voltage rating may cause irreparable damage which may not be covered by your warranty.**

---

If you are not planning to use the preamp/processor for an extended period of time, for example due to vacation or other travel, we suggest that you disconnect it from AC power.

*Make certain that the CP-800 is in **Standby** prior to disconnecting it.*

Physically disconnect any and all valuable electronics from AC power during electrical storms. A lightning strike anywhere near your home can generate a tremendous surge on the AC mains that can jump across a simple power switch. A surge from a lightning strike, which may be many thousands of volts, can cause serious damage to any piece of electronics, no matter how well designed and protected.

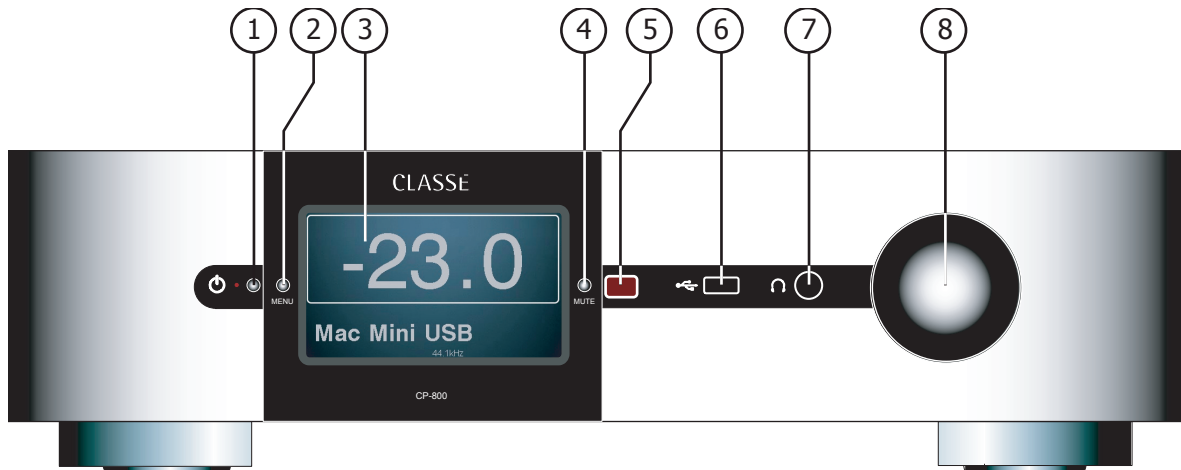

## Front Panel

The front panel of the CP-800 is shown above. The numbers in the drawing refer to the descriptions that follow.

### 1 Standby/On Button and Status Indicator LED

Pressing the **Standby** button puts the CP-800 into *standby* mode – a low-power state which leaves the preamp/processor and outputs inactive but still allows the unit to respond to system commands via any of the supported control protocols (IR input, CAN-Bus or RS-232).

If the unit is already in Standby mode, pressing the Standby button fully powers up the unit.

- LED On (Red) – the CP-800 is in Standby mode.
- LED turns cyan, then green, then off – the CP-800 is in the process of power-up initialization.
- LED On (Blue), indicates the unit is in the operate mode and the display timeout setting has been activated.
- LED Off – the CP-800 is powered on, fully operational, and the display active. If the display is not active and the LED is off, then the CP-800 is not getting AC power.

### 2 Menu On/Off Button

Press once to call up the main page of the menu system, which replaces the normal front page or Home page of the Touchscreen. Press the **Menu** button again to revert to the Home page.

The menu system gives you control over operational details including: system setup options, various display options, and custom installation capabilities so that the CP-800 integrates smoothly into the most complex systems. For more information, see the *Menu System* later in this manual.

### 3 Touchscreen

The front panel touchscreen is used for day-to-day operation of the CP-800. It is also used for setup and to display useful information as required.

#### 4 Mute Control

The **Mute** button reduces the CP-800 volume by a pre-determined amount. Pressing it a second time restores the volume to its previous level. This behavior can be easily customized for very specific user requirements. (See the section on *Volume Setup* for more information.)

*NOTE: If you increase the volume using either the front panel volume knob or the remote control while **Mute** is engaged, the mute control disengages, and audio adjustments are executed starting from the muted level. This is a safety measure to prevent accidentally restoring the volume at unexpectedly high levels.*

#### 5 IR Window

The location of the IR (infrared) transceiver for the remote control is behind this window. In most cases, there must be a clear path between the IR window and the remote control in order for the CP-800 to acknowledge the remote control commands.

If the IR window is not in view, for example if it's placed in a cabinet or closet, then the rear panel IR input can be utilized for remote control. For more details about this option, see the IR input description in the *Rear Panel* section found later in this manual.

Note that the rear panel IR ports do not function simultaneously with the IR window on the front panel. When the rear IR ports are enabled, the IR window is disabled and vice versa. In addition to receiving IR commands, the CP-800 can also transmit IR commands to third-party learning remote controls. For more details about this option, refer to the *Teach IR* description in the *Menu System* section found later in this manual. Note that the rear IR ports must be disabled to use the Teach IR function.

#### 6 USB Host Connector

The front panel USB connector allows the CP-800 to work with Apple's portable media devices such as iPad™, iPod® and iPhone® which require this type of connection. The front panel USB connector accepts digital audio from these devices as well as providing power for recharging them. Limited control is also available for these devices using the navigation keys on the CP-800 remote control.

The front panel USB connector is also used to load firmware updates. When updates are posted in the software downloads section of the Classe web site, they may be loaded onto a USB stick and plugged into the front panel of the CP-800. When the power is switched on from the rear panel, the update will proceed automatically. Once complete, the light on the USB stick will extinguish and the touchscreen will show the Home page. Remove the USB stick and continue using the CP-800. Remember that any subsequent setup changes are stored when the CP-800 is put into standby.

#### 7 Headphone Jack

The 1/4" (6.35mm) Headphone Jack accommodates stereo headphones. Inserting a headphone plug mutes the main audio outputs.

## 8 Volume Control Knob

The large rotary knob on the right side of the front panel controls the system volume level. It is also used for adjustments such as balance and input offset.

The **volume** knob increases and decreases volume in precise 0.5 dB increments throughout most of the volume range. At extremely low volume, the step size is increased somewhat to facilitate moving between extremely low and normal listening levels. The volume range is from -93 dB to +14.0 dB.

The volume control expresses the degree of attenuation or amplification being applied to the incoming signal. Therefore, a setting of -23.0 indicates that the signal is being attenuated by 23.0 dB. A volume setting of 0.0 indicates that no attenuation or amplification is being applied. This is the setting used for the Pass-Thru mode explained in the Source Setup description in the Menu System section of this manual.

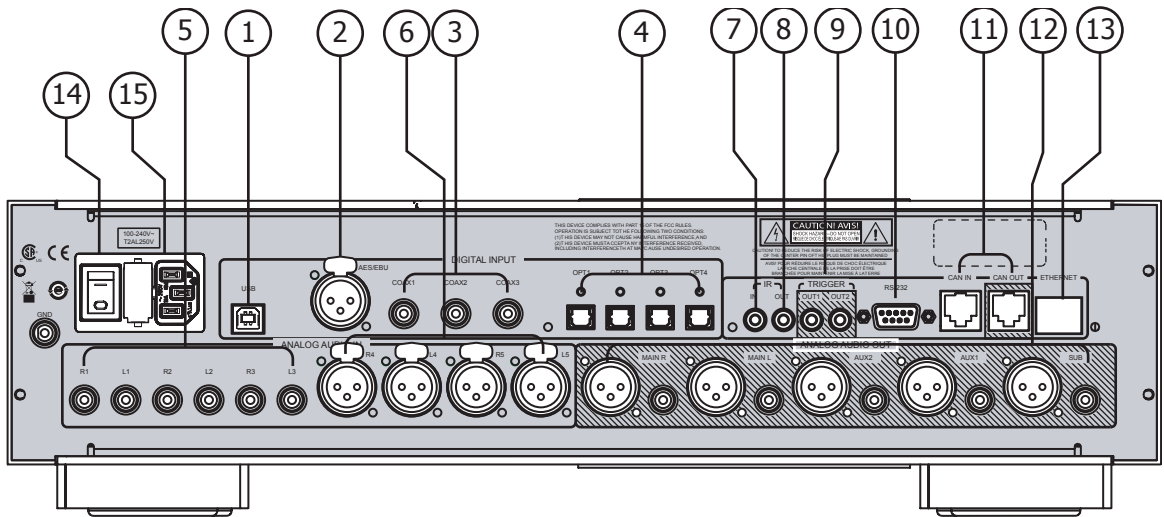

## Rear Panel

The rear panel of the CP-800 is shown above. The numbers in the drawing refer to the descriptions in this section.

serial number

You'll find your CP-800 serial number on the top right corner of the rear panel, as shown in the graphic above (the black label). Please record this number on the *Introduction Page* (page 6) of this manual for future reference.

And since you have found the serial number, please use it to register your purchase, if you haven't done so yet. We may use the information to advise you of any updates or other items of interest. Registration is simple, so please register online at [www.classeaudio.com](http://www.classeaudio.com) or fill out the registration card and drop it in the mail.

### 1 Digital Audio Input - USB

The CP-800 supports digital audio sources via USB. The rear panel USB Device connector mates with a USB Host such as a PC or Mac.

### 2 Digital Audio Input - AES/EBU

The CP-800 provides an XLR type connector for digital audio connections from source components such as CD players fitted with this professional-standard output. These inputs accept PCM data streams up to 24-bits long and up to 192 kHz sampling frequency. We recommend using cables that are optimized for digital audio signal transfer and that carry a 75Ω impedance rating. Your Classé dealer can help you with proper cable selections.

### 3 Digital Audio Inputs - Coaxial

The CP-800 supports three digital audio inputs, with SPDIF connectors labeled COAX1 to COAX3. These inputs accept PCM data streams up to 24-bits long and up to 192 kHz sampling frequency. We recommend using cables that are optimized for digital audio signal transfer and that carry a 75Ω impedance rating. Your Classé dealer can help you with proper cable selections.

#### 4 Digital Audio Inputs - Optical

The CP-800 supports four digital audio inputs, with optical Toslink™ connectors labeled OPT1 to OPT4. These inputs accept PCM data streams up to 24-bits long and up to 192 kHz sampling frequency. We recommend using cables that are optimized for digital audio signal transfer. Your Classé dealer can help you with proper cable selections.

*NOTE: The bandwidth limits of Toslink™ components are very much strained at a 192 kHz sampling frequency. For that reason we recommend keeping the Toslink™ connections at a maximum rate of 96 kHz.*

#### 5 Analog Audio Inputs - Single-Ended

The CP-800 supports 3pr of RCA type connectors for single-ended analog sources. They are labeled R1/L1 to R3/L3.

#### 6 Analog Audio Inputs - Balanced

The CP-800 supports 2pr of XLR type connectors for balanced analog sources. They are labeled R4/L4 and R5/L5.

*NOTE: This input conforms to the AES (Audio Engineering Society) "pin 2 = hot" convention. The pin assignments of these XLR-type female output connectors are:*

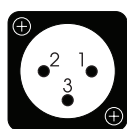

*Pin 1: Signal ground*

*Pin 2: Signal + (non-inverting)*

*Pin 3: Signal – (inverting)*

*Connector ground lug: chassis ground*

*Verify that the source components are compliant with this convention (Classé components are compliant). If not compliant, contact your Classé dealer for assistance.*

*NOTE: The Balanced and Single-Ended 2-channel analog audio inputs can be set for either bypass mode (no DSP processing) or converted to digital format to allow bass management, tone control and/or equalization. If no processing is applied, analog signals remain in the analog domain, even if not specifically set to analog bypass*

#### 7 IR Input

Use the IR input when the front panel IR window does not have a clear line-of-sight with the remote control, for instance, when the CP-800 is installed in a cabinet. Attach this input to an infrared repeater system to route signals from the remote control to the CP-800 via a mono mini-jack (3.5mm phono). Note that the rear IR ports can be enabled or disabled. When enabled, the front panel IR window will be disabled and vice versa.

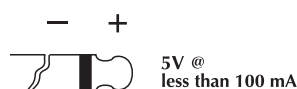

The list of available IR command codes can also be used in macros for sophisticated remote control systems, facilitating the control of the CP-800 in the larger context of the complete system.

## 8 IR Output

Use the IR output to pass IR commands from an external IR transmitter through the CP-800 to another component, when necessary. The output uses a mono mini-jack (3.5mm phono) with the same properties as the diagram in the previous section.

## 9 Trigger Outputs

The CP-800 supports two trigger outputs, with mono mini-jacks (3.5mm phono) labeled OUT1 and OUT2. Each trigger outputs a 12V DC signal at 100 mA and each can be controlled individually. Use these outputs to control other system components such as amplifiers and window blinds. Refer to the **Triggers** description in the *Menu System* section for more details.

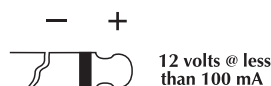

## 10 RS-232 Port

The primary purpose of the RS-232 port is to support the use of external commands to allow remote control of the CP-800 by such systems as AMX®, Control 4 and Creston™. For more information about these systems, contact your Classé dealer.

## 11 CAN-Bus Input and Output

CAN-Bus (Controller Area Network) allows several Classé components to be connected together for simultaneous operation, such as switching from *On* to *Standby*. Using the CAN-Bus Input and Output connectors, the Classé components can be daisy chained together and controlled via the CAN-Bus interface.

*NOTE: The final component in the daisy chain MUST have a termination plug inserted into the CAN-Bus output.*

For more information, refer to the CAN-Bus section found later in this manual.

## 12 Analog Outputs

The CP-800 supports five analog audio outputs, with both balanced (XLR) and single-ended (RCA) connections. Connect the Main R and Main L outputs to the Right and Left amplifier channels respectively.

The Aux 1 and 2 outputs are configurable and can be used for the following purposes:

- Assigned to mirror the main L/R speakers for use in a power bi-amplification arrangement.
- AUX 1 may be assigned as an additional subwoofer to be used in conjunction with the Sub output configured as either two stereo or two mono subs.

*NOTE: The Balanced (XLR) Output pin assignments adhere to the AES (Audio Engineering Society) "Pin 2 = hot" standard. The XLR male outputs carry the following pin assignments:*

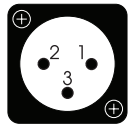

*Pin 1: Signal ground*

*Pin 2: Signal + (non-inverting)*

*Pin 3: Signal – (inverting)*

*Connector ground lug: chassis ground*

*Refer to the operating manuals of your balanced-input power amplifiers to verify that the pin assignments of their input connectors adhere to this standard (Classé power amplifiers are compliant). If your amplifiers are not compliant, it may not pose a problem, but ask your Classé dealer for assistance.*

### **13 Ethernet Connector**

This connector is provided for an optional hardware module that will be made available in the future. It is inoperable until the optional module has been installed.

### **14 Main Power On/Off Switch**

This switch connects and disconnects the CP-800 from AC.

### **15 AC Power Cord Input**

The detachable three-conductor AC power cord and the socket into which it connects conform to rigorous standards developed by the IEC (International Electrotechnical Commission).



**Danger!**

---

**Your CP-800 contains potentially dangerous voltages and current capabilities. Do not attempt to open it! There are no user-serviceable parts inside. All service must be referred to a qualified authorized Classé dealer or distributor.**

---

# The Remote Control

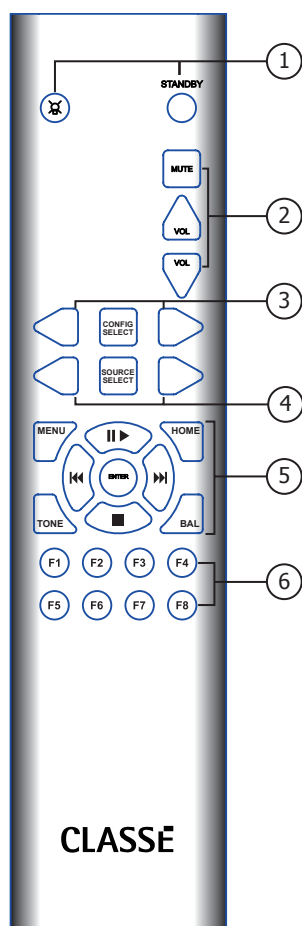

Your CP-800 Stereo Preamp/Processor includes a versatile remote control for both the Preamp/Processor itself and several aspects of the rest of a Classé-based system. The buttons are arranged in logical groups according to their functions. The remote control of the CP-800 is shown on the left. The numbers in the drawing refer to the descriptions that follow.

## 1 Basic Functions

The two buttons along at the top of the remote control groups the following basic control functions:

- **Light** turns on the backlighting of the remote control for better visibility under low-light conditions. After a few moments of inactivity, the backlight switches off automatically.
- **Standby** switches the CP-800 between the *Standby* and *Operate* states.

## 2 Volume Control & Mute Buttons

The **Volume Up** and **Down** arrow buttons increase or reduce the overall volume level of the audio output. Pressing the **Mute** button reduces the audio output volume level by a pre-determined amount. You can customize selected features of both the Mute button and volume level. Refer to the *Volume Setup* description in the *Menu System* section found later in the manual for further instructions.

## 3 Config Select Buttons

The left and right arrow buttons step through the six configurations. If there is a different configuration assigned as a default for a particular source it will be overridden until the source is selected again, or you select that particular default configuration.

Pressing the CONFIG SELECT button will open the configurations page, making it easier to navigate to a specific configuration. Use the positions of the underlined buttons on the screen rather than trying to read their names from across the room.

## 4 Source Select Buttons

To change inputs, simply use the **Source Select** arrow buttons to step through the inputs.

Pressing the SOURCE SELECT button will open the Source Selection page, making it easier to navigate to a specific source. Use the positions of the underlined buttons on the screen rather than trying to read their names from across the room.

To keep your input selection list smaller and easier to navigate, the Source Select buttons will toggle only through those inputs which are enabled. Refer to the *Menu System* section found later in the manual for further instructions.

## 5 Navigation & Menu Buttons

The remote control contains the navigation buttons and the menu access buttons. This array of buttons is used for navigating the menu system on the CP-800 as well as providing basic transport controls to USB-connected sources. Each of the buttons performs the following function(s):

- **Menu** accesses the main screen for the menu system, in the same fashion as the front panel **Menu** button.
- **Home** returns the touchscreen display to the *Home* page. The **Home** button essentially acts like a “back to start” button – no matter how deeply you’ve navigated into the menu system, a single button push returns you to the front page.
- **Navigation Arrows** are located in the familiar **Up** (▲), **Down** (▼), **Left** (◀), and **Right** (▶) arrow positions which allow you to select the different menu options within the menu system. When on the home page, these buttons instead serve as transport controls for USB sources with the typical play/pause, stop, scan/skip forward and scan/skip backward commands.
- Pressing the **Enter** button selects the underlined menu item in any menu screen.
- **Tone** accesses the Tone Control screen. Pressing Tone while on the Tone Control screen activates the tone control. Subsequent presses toggle between active and not active. While on the Tone Control screen, the volume up/down keys increase or decrease the tone control. See Tone Control Setup in the Menu System section for more information.
- **Bal** is used to access the Left/Right balance. Use the Volume arrows to adjust the L/R balance.

## 6 Function Keys (F1 to F8)

The last eight buttons on the remote control are the **Function** buttons, or Fkeys, which provide additional flexibility to the CP-800 remote control. Think of them as “favorite” buttons that provide direct access to specific functions or commands not covered by the other buttons. Refer to the **Remote Fkeys** description in the *Menu System* section found later in the manual for more information.

# Initial Setup

Your CP-800 Stereo Preamp/Processor is delivered with default factory settings to facilitate initial setup. But we highly recommend that you work with your Classé dealer for the final setup of the preamp/processor. Your dealer's knowledge and experience with Classé products will ensure that your audio system is optimized for your listening space.

However, if you can't wait to get started, this section is designed to assist you in setting up and becoming familiar with the CP-800 hardware. Once the initial setup is complete, be sure to read the rest of this manual to familiarize yourself with the daily operation and customizable features of your CP-800.

## Step 1 **Connect the CP-800 and all system components to AC power.**



**Important!**

---

**Make sure everything – especially your power amplifier(s) – is turned off before connecting power!**

---

Connecting all system components to AC power, before making any interconnections between components, ensures that every component has a solid connection to ground. This lessens the chances of a static discharge that may damage delicate electronics or your loudspeakers.

## Step 2 **Choose the appropriate cables.**

Before you start connecting components together, let's take a minute to discuss the cables you will be using. The audio outputs available on the rear panel include both balanced XLR connectors and unbalanced, or single-ended, RCA connectors.

Single-ended RCA audio connections are the most popular means of transmitting audio in consumer electronics. As long as you use high quality, low capacitance cables, single-ended connections provide very satisfactory results.

However, balanced audio connections between components provide the best analog signal connection because they effectively double the signal strength. More importantly, as compared to single-ended connections, they significantly improve resistance to common mode noise, therefore enhancing audio transparency, detail, and dynamics.

Please consult your local Classé dealer for advice on which cables are best suited for your system.

## Step 3 **Connect source components to the CP-800 rear panel.**

If necessary, refer to the *Rear Panel* section in this manual for a detailed description of each connector found on the rear panel. Your local Classé dealer can also provide useful suggestions for what source components you should add to your system and guidance in setting them up.

---

**Make sure you keep a detailed record of the rear panel connectors that you used while connecting the source components!**

---

You'll need to know what connector(s) each source is attached to when you enter the setup menus. An *Installation Worksheet* is included at the end of this manual to assist you.

*NOTE: In the CP-800 default settings, fifteen rear panel inputs are associated with corresponding source selections within the Source Setup menu. Since most users will have fewer sources connected, the Source Selection page(s) can be simplified by unchecking the Enable Source box for each unused input. Doing so removes the corresponding Source button from the Source Selection page. See the Menu System section for details.*

Step 4 **Connect the power amplifier(s) to the CP-800 rear panel.**



**Important!**

---

**Verify that the power amplifier(s) is plugged in but powered OFF before connecting to the CP-800!**

---

We recommend using high quality cables with XLR connectors.

*NOTE: These pin assignments are consistent with the standards adopted by the Audio Engineering Society. Refer to the operating manuals of your balanced-input power amplifiers to verify that the pin assignments of their input connectors correspond to the CP-800. If you are using Classé amplifiers, this note does not apply.*

*If needed, the pin assignments of the XLR-type male output connectors are:*

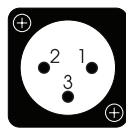

*Pin 1: Signal ground*

*Pin 2: Signal + (non-inverting)*

*Pin 3: Signal – (inverting)*

*Connector ground lug: chassis ground*

Connect the Main L&R Outputs, either RCA or XLR, from the rear panel of the CP-800 to the corresponding inputs on your amplifier(s).

- If you are using a subwoofer, connect the CP-800 subwoofer output to the input of the designated amplifier or powered subwoofer.

*NOTE: Make sure connections from the subwoofer output go **only** to an amplifier connected to a subwoofer or a powered subwoofer, as low frequency signals can damage a small speaker not designed for high output bass reproduction.*

When connecting a cable, make sure the cable has a good connection and is firmly attached to the rear panel connectors on both the amplifier and the CP-800.

The CP-800 also provides two **Auxiliary** analog audio outputs. See the section on Configuration Setup for more details about the Auxiliary outputs. If used, connect the AUX output(s) to its corresponding amplifier(s) or subwoofer.

#### Step 5 **Connect the loudspeakers to the amplifiers.**



#### **Important!**

---

**Verify that the power amplifier(s) is plugged in but powered OFF before connecting to the CP-800**

---

Connect each loudspeaker to its designated amplifier(s) channel. Pay close attention to the phase of the speaker connections – *always connect an amplifier's red (+) terminals to the red (+) terminals of the loudspeaker. Likewise, connect black (-) terminals to black (-) terminals.*

#### Step 6 **Power up the system!**

Now you are ready to power up your CP-800 and your audio system.

- Turn the rear panel power switch of the CP-800 to **ON**. The Standby LED will turn red.
- Press the standby button located next to the LED. The initial power-up cycle of the CP-800 takes a few seconds.
- When the power-up cycle is complete, the CP-800 enters Operate mode and the touchscreen becomes active.
- Press the **Standby** button to toggle the CP-800 into and out of Standby.

The physical setup of the CP-800 and system components is complete.

# Using the CP-800

The CP-800's versatile touchscreen LCD supports your day-to-day operations and provides access to a flexible menu system for controls and setup functions that aren't accessed as often. This section of the owner's manual outlines the use of the touchscreen in routine operation of the system.

When you bring the CP-800 out of *Standby* mode, the touchscreen displays the Home page of the menu system, as shown below.



The **Home** page displays the volume in large font which is easily visible from across a room. The selected source appears at the bottom of the screen. At the bottom center of the screen the format of the incoming signal is displayed. This displays the sampling frequency of digital sources or Bypass if so selected for analog sources. If and Pass-Thru is selected for either digital or analog sources, the volume display will read 0.0 and be greyed out (since the volume control is not active in this mode).. This page can be quickly accessed at any time by pressing the **Home** button on the remote control or tapping the home icon on the touchscreen display.



source selection

Touching the screen when on the Home page brings up the Source Selection page. The number of source buttons appearing here corresponds to the number of inputs that have been set up and are "enabled." A maximum of nine sources may appear on one page. If more are enabled, they will be available on the next page by touching the  button in the upper right corner of the page. See the section on source setup in the Menu System. The CP-800 has up to 18 selectable source buttons which are all interchangeable.



Touch any **source** button on the touchscreen to select it as the current source. The selected source button is shaded. If the source you want to choose is not on this screen (and you have more than nine source buttons enabled), press the  button for the next page of sources. Or, press the  button to return to the previous page.



The CP-800 comes from the factory with fifteen source buttons labeled and enabled. To change the default settings and labels or to disable unused buttons, see the Menu System.

# The Menu System

The comprehensive menu system provides setup and configuration controls for the CP-800. These installation-specific features let you customize how the CP-800 works within the context of your particular system.

Pressing the **Menu** button on the front panel or remote control opens the main Menu page, which is divided into six sections as shown below.



At the top right of the menu pages you may find a  button which uses the arrow icon when additional menu options are available, and/ or a **Home** button for returning to the Home page. When on the main Menu page, pressing the **Menu** button returns to the Home page. If you are on a page within the Menu System, pressing the Menu button returns you to the main Menu page. When you navigate beyond the main Menu page a return or back button using the  icon appears on the upper left corner of the page. This steps you back to the previous page.

## System Setup

Touching the **System Setup** button on the main Menu page opens the System Setup page, which contains nine setup options as shown below.



From the System Setup menu, you can:

- tailor your inputs to your particular source components
- configure the system to take best advantage of your loudspeakers
- tailor the display to your preferences
- set volume control parameters
- enable and setup the Parametric EQ
- setup Tone Control parameters
- teach IR commands
- choose Remote F key functions
- assign DC triggers

### *Source Setup*

Each of the 18 source buttons supported by your CP-800 can be customized in several ways to enhance system performance or to simplify operation. The source select page is dynamic in that it shows up to nine sources on a single page. If six or fewer are enabled, then the page shows six somewhat larger buttons and if three or fewer are enabled, it shows only three large buttons. Press the button for the source you want to set up. The setup page for that source includes buttons for assigning the input connector(s) and naming the source, choosing a default speaker configuration, setting an input offset, selecting the Pass-Thru feature or choosing the Analog Bypass path.



### *Enable Source*

This check box activates/deactivates source buttons. If the **Enable Source** box is checked, then the source is enabled. If the Enable Source box is NOT checked, then the source is considered not enabled and is so identified on the source selection page.

Disabling unused sources is a good way to simplify source selection. The Source select page is dynamic, adjusting the number and size of buttons to correspond to the number that are actually being used or enabled. The buttons arrange themselves into groups of either three, six or nine buttons on the Source Select page.

### *Input Connector*

Choose the input connector(s) to be associated with this source button. Any source button may be associated with any input connector(s). Also, multiple source buttons may be assigned to the same connector(s).

<i>Source Name</i>	<p>The <b>Source Name</b> button provides a way to customize the names of the sources as displayed on the source selection screen(s). For example, if you have an outboard phono stage plugged into the Line 1 analog inputs, you might want to rename the source button Phono to make it easier to remember.</p> <p>To change source names, use the keyboard on the touchscreen. Note that the size of the source buttons varies depending whether you have 1-3, 4-6 or 7-9+ sources enabled, so the length of name that may be fully displayed on the button will likewise vary.</p> <p>After entering the source name, press Enter on the keyboard to save the change.</p>
<i>Configuration</i>	<p>The <b>Configuration</b> button allows you to assign one of the up to six configuration options as the default for the source button being set up. Whenever this source is selected, that configuration will be employed. You might set up one source such as a disc player to have a default configuration with a subwoofer crossed over at 80 Hz for movies. You may then set up another source button for the same disc player with a different default configuration, say one with a subwoofer crossed over at 40 Hz, for music. Configurations are speaker setups, and are discussed in more detail later in this section.</p> <p><i>NOTE: The default Configuration assignment can be temporarily overridden from the remote CONFIG SELECT buttons or from the <b>Configurations</b> button on the main Menu page. See the section, Using the CP-800, for more details.</i></p>
<i>Input Offset</i>	<p><b>Input Offset</b> is used to ensure that all sources playback at comparable level. There can be significant differences in output levels, especially among analog sources, which can lead to unexpected changes in volume when switching among them. The CP-800 provides an input offset adjustment range from -10 to +10 dB.</p>
<i>Pass-Thru</i>	<p>Selecting <b>Pass-Thru</b> locks the volume at 0.0 dB for this source and passes the signal through the preamp without changing its level. This feature is useful to avoid having two volume controls active such as when the preamp sits between an SSP and the L&amp;R channel amplifiers. <i>Note that the Pass-Thru mode is available for digital as well as analog sources.</i></p>
<i>Analog Bypass</i>	<p><b>Analog Bypass</b> is available for sources associated with analog input connectors. It determines if the incoming analog signal is converted to digital format or left in an analog format. If Analog Bypass is NOT selected and a configuration that requires digital signal processing is selected, then the CP-800 converts the incoming analog signals to digital for further processing such as bass management, EQ and tone controls. <i>NOTE: It is possible to choose bypass and enable subwoofer output(s) at the same time, but the Main L&amp;R signals will pass through the preamp/processor in the analog domain without high pass filtering.</i></p>

## Configuration Setup

The **Configuration Setup** page allows you to define up to six different speaker configurations. Touch the button for the specific configuration you want to set up to open its configuration setup menu. The page contains buttons for naming the configuration and enabling balanced (XLR) and single-ended (RCA) outputs for Main, Aux and Subwoofer channels. Choosing a subwoofer output causes a Bass Management button to appear. The same menu is used to set up each configuration.

## Configuration Name

As with naming sources, press the Configuration Name button to access the keyboard used for customizing the configuration name. *Remember to press Enter after making your changes to save the new name.*

## Configure Outputs

Choose the output connectors you want enabled with this configuration. If a subwoofer (or two) is used, a Bass Management button appears, allowing you to set crossover frequency and slope, or enable stereo or two mono subwoofers.



If you also want to High-Pass Filter the L&R outputs, check the box for L/R HP Filter. The crossover will pass the higher frequencies and correctly direct the low frequencies to the subwoofer(s) based on your frequency and slope settings. If this box is unchecked, L&R channel signals pass full range and the lower frequencies are duplicated by the subwoofer(s). This may result in too much bass, especially at certain frequencies, so equalization may be required to compensate.

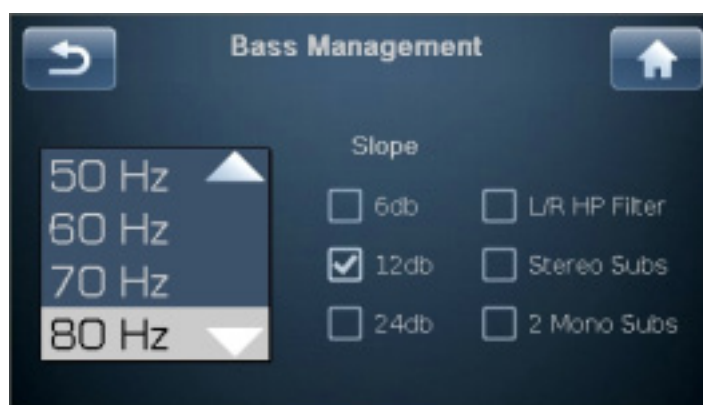

## Auxiliary Channels

The CP-800 has two auxiliary channels that can be utilized for bi-amping the L&R speakers. Alternatively, Aux 1 may be used in conjunction with the Sub output to provide a second mono subwoofer or stereo subwoofer configuration.

If either the single-ended or balanced Aux channel outputs are enabled and no more than one subwoofer is being used, then the aux channels are considered to be active in bi-amp mode. Technically, this is called power biamping. Separate amplifier channels are used for the high and low frequency drivers of your loudspeaker, but the passive crossovers in the speaker do the work of filtering low and high frequency signals. In this mode, the two auxiliary channels produce the same output as the Main Left and Right channels.

*NOTE: When bi-amping with two different amplifiers on each speaker, the amplifiers must have the same gain in order to ensure proper level matching between the upper and lower frequencies. All Classé Delta and CT series amplifiers have the same gain and may be used in any combination for bi-amping.*

## Display Setup

The Display Setup menu page, shown below, allows you to configure the brightness and display timeout used for the touchscreen display.



## Brightness

The **Brightness** setting of the CP-800 touchscreen has three possible values: *low*, *medium*, and *high*. Select the setting you prefer. A *high* brightness setting usually works best in brightly-lit rooms; you may find that a lower setting is less visually intrusive under more subdued lighting conditions.

## Timeout

If you prefer listening to music in a dimly-lit or darkened room, you may find even the *low* brightness setting of the display somewhat distracting. You can essentially turn off the touchscreen by reducing the **timeout** value of the backlighting so as to turn it off entirely after a period of inactivity that you may select. In this context, activity refers to any use of the user interface. This includes hard buttons, the touchscreen, and the remote control.

For example, if you reduce the timeout to its minimum setting, the backlighting illuminates the display as soon as you interact with any of the CP-800 controls, and remains lit for only three seconds – just long enough for you to check a setting. If you continue to use any of the controls (at least once every three seconds), the display remains lit. After three seconds of inactivity on your part, the backlight extinguishes itself, essentially turning off the touchscreen.

If you prefer the display of the CP-800 to remain on whenever not in *Standby* mode, select the **Never** timeout option. The lamp in the touchscreen display is designed for harsh automotive environments and will give you many years of reliable operation. If you plan to leave the unit on continuously, however, we recommend that you keep the timeout delay set to less than one minute.

*NOTE: setting the brightness to a lower setting does not increase the life of the lamp.*

## Volume Setup

Touching the **Volume Setup** button in the System Setup menu opens the Volume Setup page, as shown below. The volume knob is used to make all volume setup adjustments.

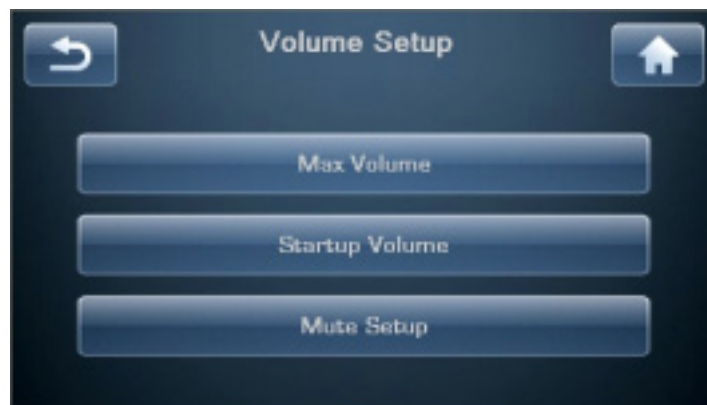

Volume Setup allows you to:

- set a maximum volume level
- choose an initial volume level for the system whenever the CP-800 is brought out of Standby
- customize the behavior of the mute control

### *Max Volume*

The Max Volume page allows you to establish a maximum volume setting for your system. This scale runs from -93.0 to +14.0, with +14.0 dB indicating that you do not want any artificial limit placed on the maximum gain your CP-800 can provide. This setting is interactive. It is easiest to play the system at increasing levels until you reach the volume which you want to use as the maximum for the system. Using the volume knob, enter that value on the Max Volume page.

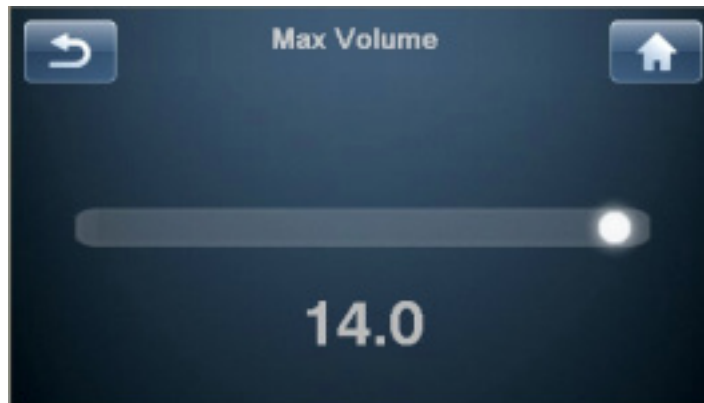

### *Startup Volume*

Touching the **Startup Volume** button allows you to set up a preferred volume level for when the CP-800 wakes out of standby.

- The factory default is for a startup volume set to -30.0.

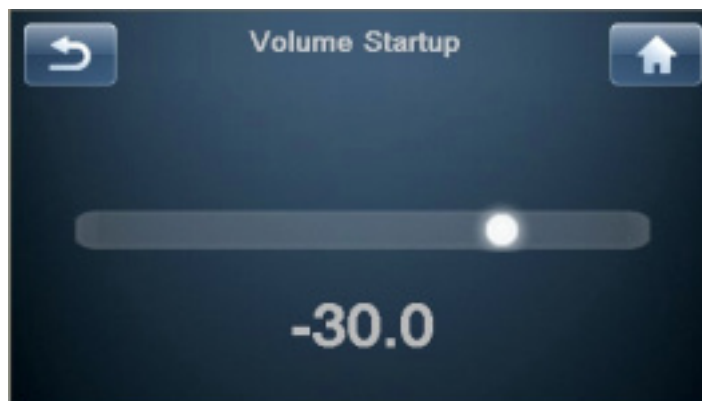

## Mute Setup

The Mute Setup page allows you to choose how the **Mute** button functions. The options for mute control are:

- **specific** - allows you to select the exact value to which the volume is attenuated. If the current volume is already below that level when muting is engaged, the volume remains unchanged. The factory default is - - -, which is fully muted.
- **dampening** - reduces the current listening level by a specified amount (like -25.0 dB).

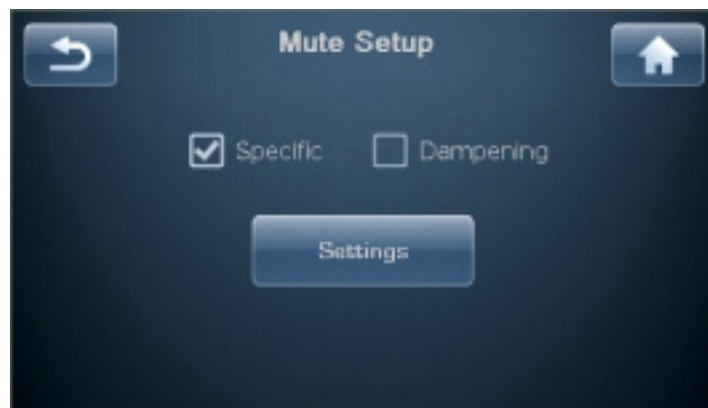

## EQ Setup

The CP-800 Parametric EQ capability allows you to build very precise digital audio filters to help compensate for fixed sonic irregularities defined by the location and characteristics of your speakers, your room and your listening position in the room. These filters should be constructed based upon audio measurements made by a well-qualified acoustical engineer. These powerful filters are made available in a completely manual fashion to help your professional installer give you the best listening experience possible.

As many as five filters can be built for each speaker channel. An Aux channel not being used as a subwoofer assumes the same filters as defined for its Left or Right channel partner.

In order to define the PEQ filters, select **EQ Setup** from the System Setup menu. Check the box to enable the EQ. Choose which channel you wish to adjust, select a band and enable its filter, then tune it with the appropriate center frequency, gain, and Q.

You do not need to have all or even any filters enabled for every channel. The installer need only make the adjustments to the channels necessary to correct for the room's interaction. *We encourage you to consult with your authorized Classé dealer to properly calibrate the Parametric EQ function.*

*NOTE: that a discrete IR command or Fkey may be used to toggle the EQ on and off to easily compare before and after from the listening position. When the EQ is enabled, EQ appears on the Home page.*

## Tone Control Setup

The tone control may be configured as conventional bass and treble controls or used as what is sometimes called a tilt control. In either configuration the maximum boost and cut is 6.0 dB.

The default setting configures the tone controls as a tilt control with low- and high-frequency inflection points at 200 Hz and 2000 Hz respectively. These values are user adjustable, allowing customization of the frequency ranges manipulated by the tilt control.

When on the Tone Control screen, pressing the volume up button on the remote or rotating the volume knob clockwise will tilt the control up in the high frequencies and down in the low frequencies, stepping in 0.5 dB increments. Pressing the volume down button or rotating the volume knob counterclockwise reverses the effect, increasing low frequencies while decreasing the highs. In general, this allows for subtle shifting of the tonal balance toward a more lean or warm sound respectively.

If conventional bass and treble controls are desired, select that option and choose the frequencies below which the bass control works and above which the treble control works. The bass and treble controls may be accessed from the touchscreen (Menu, Tone Control) or by pressing Tone on the remote. Use the navigation buttons on the remote or the touchscreen buttons to increase or decrease the level of bass and treble independently. The Tone Control is activated and deactivated by successive pressing of the Tone button on the remote or selecting and deselecting the Enable box on the touchscreen.

## Teach IR

The complete list of CP-800 discrete infrared (IR) command codes extends beyond what is practical for any one handheld remote control. However, many of these functions are critical if you plan to create a customized remote control with macros that take command of your entire system. Without these discrete codes, many of the macros you might want to create simply won't work reliably.



The Teach IR page displays a scrolling list of all the available IR codes in the CP-800. Simply scroll to the command you want your macro-capable remote to learn and touch the **Send IR Code** button. The CP-800 continuously sends that command code via the front panel - as long as the button is pressed – until your third-party remote control has learned it.

For more information on control systems, we recommend you speak with your authorized Classé dealer.

## Remote Fkeys

The remote control supplied with the CP-800 has eight **function** keys (**Fkeys**), each of which can give you instant access to specific system functions.

For example, if you want direct access to particular sources or configurations, you may want to consider programming some of the **Fkeys** to directly access them. By assigning them as Fkey functions, you do not need to use the arrow keys to scroll through the active sources or configurations looking for them.



The remote control **F1** to **F8** buttons correspond to the Function Keys displayed on the touchscreen. Select the **Function Key** that you would like to assign, then scroll through the list and choose the specific function you want that **Fkey** to perform.

### Important note on Fkey use

All Classé Delta and CT series remote controls provide at least four **Fkeys**. Commands F1-F4 on every Classé remote send the same IR signals as F1-F4 on every other Classé remote, so you do not need to worry about which remote you've picked up. Thus **F1** on the CP-800's remote control sends the same infrared signal as **F1** on the CD player's remote control and so on.

While this is intended to minimize confusion amongst different remotes (since this aspect of them will all perform identically), you should take care when assigning different functions on different components to the same **Fkey**. Doing so can result in two components doing two different things at once, in response to a single press of a button on the remote control. This can sometimes be useful. As an example, **F1** could set the CP-800 to the **CD Player** input, and also set the CD player to **Play**, both from the press of a single Fkey.

## DC Triggers

The CP-800 has two available trigger controls. Each may be programmed using normal 12 V or “inverse logic” (0 V) settings. The ability to change the way the trigger operates can solve installation-specific problems that otherwise require external devices that add to both the cost and complexity of your system.



The triggers can be associated with the Standby mode, a specific source or a configuration. To use the Inverse Logic option, simply check the Inverse Logic box on the Trigger Setup page.

For more information on the potential use of DC triggers, we recommend you speak with your authorized Classé dealer.

## Tone Control

Setting up the Tone Control involves choosing high and low frequency inflection points, and relative cut or boost for them. The factory default settings create what is sometimes called a tilt control, which tilts the tonal balance either toward more high and less low frequency for a leaner, crisper sound, or the opposite direction toward a warmer, fuller sound.

*NOTE: To change these parameters, press MENU, then System Setup, Tone Control Setup.*

If conventional bass and treble controls are preferred they may be configured using the Tone Control Setup page as described in the Menu System section. Press Tone on the remote or MENU then Tone Control on the touchscreen to access the tone control. The Tone Control is activated by selecting the Enable box on the touchscreen. Alternatively, pressing Tone on the remote when on the Tone Control screen toggles the control on and off. When the Tone Control is enabled, Tone appears in a box on the Home page. The Volume up/down buttons on the remote and the volume knob on the unit are used to increase or decrease the effect of the tone control when in tilt mode. When used as conventional bass and treble controls, the Boost and Cut buttons on the touchscreen are used for increasing or decreasing the corresponding tone control levels. These controls may also be accessed by pressing Tone on the remote control and using the navigation keys. The adjustment range is +/- 6 dB in 0.5 dB increments.

## Balance

To adjust the L/R Balance, when on the Balance page, use the volume knob or the volume up/down keys of the remote control. Balance is adjusted in 0.5 dB increments by alternately boosting and cutting 0.5 dB from each channel. In this way, the overall level stays roughly the same as the balance shifts. The Balance control works by making adjustments with the master volume control, so no additional circuitry enters the signal path when balance adjustments are made.

The Balance control offers a range of +/- 10.0 dB and moving the control to either extreme turns off the opposite channel (used mostly for troubleshooting).

*NOTE: Your L & R speakers may not produce the exact same output for a given input, or their location in the room or relative to your listening position may contribute to a perceived imbalance of up to a few dB. To compensate for this, play a simple vocal recording and put the CP-800 in Mono (press Menu, then Mono). Open the Balance control page and using the remote, adjust the balance until the sound image is perfectly centered. If you close your eyes and do this a few times, you will find that one number, like Right 1.5 dB, may appear consistently. If so, you know that is the adjustment your system requires. Leave the setting there, return to normal stereo operation and then forget all about the balance control.*

## Configurations

You may create up to six different output configurations to accommodate preferences like with or without subwoofer(s), or with subwoofer(s) having different crossover settings. While these configurations may be associated with specific sources, they may also be called from the Main Menu page or the remote control. Pressing the Configurations button in the Main Menu or choosing Config Select on the remote opens the Configurations page. Choose the configuration you wish to employ.

To customize configurations, see the Configuration Setup description in the System Setup section.

## Mono

Pressing the Mono button combines L & R channels, resulting in monaural output on all channels (including Auxiliary and subwoofer channels). When in Mono, the Mono button is shaded. Press again to deselect and return to normal stereo operation. When in Mono, the word Mono appears in a box on the Home page.

## Status

The Status screen provides several items of information on the currently selected source and configuration as well as access to information on the firmware used in and the internal settings and sensors of the CP-800. While on this page, pressing the more button will access the **CAN-Bus** features for connected Classé components.

**CAN-Bus** Classé's Controller Area Network, or CAN-Bus, opens the way to a new level of interaction between our CAN-Bus-equipped amplifiers, preamps, processors and source components. When the CP-800 is connected with CAN-Bus, the different elements of a CAN-Bus-connected system are in constant communication, creating a "global" network that delivers system wide status information and shared operational features, all through the touchscreen display.

features CAN-Bus will allow a single touchscreen to:

- Display status information for every connected unit, including amplifiers which do not have a touchscreen display.
- Create a "PlayLink" that allows a CP-800 or an SSP to automatically switch to the correct input when a Delta series source component starts playback.
- Adjust the global system brightness.
- Configure the entire system to go in and out of standby at the touch of a button and also bring individual components in and out of standby.
- Mute any connected unit.

hardware setup

**1 Classé Delta Series Products**

Two or more Classé Delta and/or CT series products are required, at least one of which must have a touchscreen display.

**2 Category 5 Network Cables**

These are ordinary network cables, commonly used for broadband Internet connections. They should be typical "straight through" cables not the "crossed over" type, and the total required will be one less than the total number of Delta and/or CT series components in your system.

### 3 CAN-Bus Terminator

A CAN-Bus Terminator will be required. It is inserted into the CAN-Bus OUT connector of the last component in the CAN-Bus daisy chain. One is included in the box with your CP-800. They are also available free of charge from your nearest Classé Customer Support Center <http://www.Classeaudio.com/support/service.htm>

The diagram below illustrates how to connect the CAN-Bus hardware.

*Any combination of models in any order.*

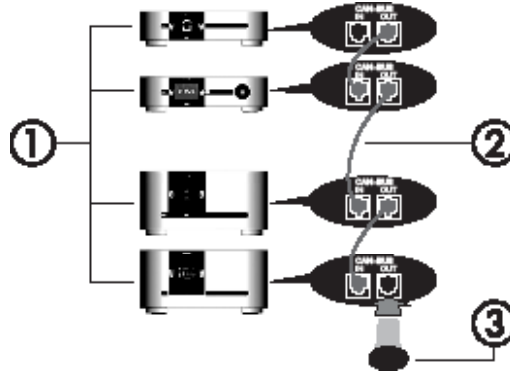

*NOTE: Daisy chain must be terminated with CAN-Bus Terminator.*

using CAN-Bus

CAN-Bus is controlled via the touchscreen of any Delta or CT series component. There is no master component, so Delta/CT series systems where two or more units have a touchscreen can be controlled through any of the touchscreens. However, it is probably easiest to start using CAN-Bus through just one.

CAN-Bus is accessed by pressing the **menu** button on the face of the unit or remote, then the **status** button, followed by the  button.

The touchscreen will then display the **CAN-Bus devices** screen, which lists connected Delta/CT series components by model & serial number.

Highlighting a unit on the CAN-Bus devices screen identifies it as the **target unit**. The front panel LEDs of the target unit will start flashing (unless you highlight the unit that you are using to access CAN-Bus).

Once you have chosen the target unit press **select**. The target unit's LEDs will stop flashing and the touch screen will list the CAN-Bus features available to it. Some CAN-Bus features are shared by all models, some are specific to individual models.

## CAN-Bus shared features

The following CAN-Bus features are shared by all models.

### *configuration*

Selecting **configuration** will present the **CAN-Bus configuration** screen allowing access to name, global brightness, and global standby features..

- **name** enables you to set the name that this component will be listed under in the CAN-Bus devices screen. The name will appear next to the unit model and serial number, and facilitate the identification of units in large systems.
- **global brightness** enables you to adjust the touchscreen and LED brightness of all the components in your system by changing the brightness of a single touchscreen. All CAN-Bus software updates automatically set the updated unit to global brightness. If you want a particular unit to be excluded from global brightness, deselect global brightness for that unit.
- **global standby** enables you to bring your entire system in and out of standby by pressing the standby button of any unit or remote. All CAN-Bus software updates automatically set the updated unit to global standby. If you want a particular unit to be excluded from global standby, deselect global standby for that unit.

### *operate*

The **operate** settings allow you to bring the target unit in and out of standby, or mute. This key will be disabled for the unit whose touchscreen you are using to access CAN-Bus.

### *AC status*

The **AC status** screen displays information from the target unit's electrical supply sensors. Two screens are available, with the second accessed by selecting **more**.

### *status*

The **status** screen is the simplest way to access essential information about the target unit. It displays the target unit's model number, software version, operational status and serial number.

## CAN-Bus model specific features

The following CAN-Bus features are model specific.

### *PlayLink*

This feature is exclusive to Delta series disc players and will only function if the disc player is connected to a CAN-Bus enabled preamp or surround sound processor.

When **PlayLink** is active, pressing **play** on the disc player will also automatically switch the preamp/processor to a specified input. This means that you can listen to a CD or watch a DVD literally at the touch of a button.

The first step in using PlayLink is to choose the **input** you wish to be selected when play is pressed on the disc player. Press the **PlayLink** icon, then select the correct input from the list.

Once you have selected the input press **back**, then select **configuration**. PlayLink is activated and disabled through the PlayLink icon on the CAN-Bus configuration screen.

PlayLink is automatically active after a software update, and the PlayLink icon will only appear on the CAN-Bus configuration screen of a Delta series disc player.

*PlayLink can only select a single source per preamp/SSP per disc player. It is therefore not designed for users who regularly play both CDs and DVDs through different source buttons from a single disc player. When PlayLink is active the disc player will default to the same input every time play is pressed, regardless of whether it is playing CD or DVD.*

*amp info* Available for amplifiers only, this screen displays the data provided by the heatsink and AC Module temperature sensors.

*NOTE: This feature is only accessible when the target amplifier is on.*

*event log* Reserved for amplifiers, this feature is a protection circuitry **event log** which can only be accessed when the target amplifier is in **standby**. The protection circuit shuts down the amplifier or channel if it overheats or if its output could damage your speakers. The event log details the circumstances surrounding the amp going into protection and should be referred to in situations that require the intervention of your dealer or Classé customer support.

The log can report the following events interpreted as follows:

- **+ve slow blo trip & -ve slow blo trip** — The average current has reached the safe operating limit.
- **+ve fast blo trip & -ve fast blo trip** — The peak current has reached the safe operating limit.
- **over temperature trip** — The unit temperature has reached the safe operating limit.
- **DC protection trip** — The DC output level has reached the safe operating limit.
- **Communication failure** — There has been a loss of communication between the amp's system monitoring sensors.
- **AC line trip** — The power supply has reached the limits of the amp's safe operating range.

These events are rare and generally occur due to issues that are external to the amp. They should be interpreted positively. The amp is doing what it's designed to do.

# Troubleshooting

Always refer any service problems to your Classé dealer. However, if you run into a problem, we recommend referring to this section first as sometimes an error is not a malfunctioning product, but simply an oversight in the proper setup of the component. This section provides suggested solutions to potential problems.

If none of these solutions work, please consult your Classé dealer for assistance.

**There are no user-serviceable parts inside the CP-800.**



**Important!**

---

**Verify that the power amplifier(s) connected to the CP-800 is powered off before checking any cable connections and before power cycling the unit.**

---

## **1 Everything appears to be powered on, but there is no sound.**

- ✓ Adjust the volume control to a moderate level - audible but not excessive.
- ✓ Make sure that the selected source component is powered on, not in Standby mode, playing an audio track, and not in pause mode.
- ✓ Ensure that the proper connector has been selected for the current source.
- ✓ Verify that the Mute control is NOT engaged. This also applies to sources such as USB connected devices. For example, muting iTunes will result in no output even though the CP-800 is setup and operating properly.
- ✓ Ensure that the amplifier is powered up and not in *Standby* mode.
- ✓ Check the *Menu* -> *Status* page to verify an audio signal is being received.
- ✓ Verify that all cables are securely connected to the proper inputs and outputs, with no kinks or stress points.

## **2 There is no sound and neither the Standby LED nor the touchscreen is lit.**

- ✓ Ensure that the CP-800 is properly connected to the electrical outlet - the AC cord is positioned firmly in the AC mains receptacle in the rear panel and the power switch is in the **ON** position.
- ✓ If the CP-800 is properly plugged in and the power from the electrical outlet is at the proper level, try the following: Put the CP-800 in *Standby* mode, switch off the main power switch on the rear panel, and unplug the unit for at least thirty seconds. Then plug the cord back in and try powering up again. Sometimes, a brown-out (short-term power loss/drop) can activate a protection mode, which requires a power cycle to reset the CP-800 to its normal operating mode.
- ✓ Remove the AC cord from the unit, and open the fuse holder adjacent to the AC cord inlet. If the fuse is blown, contact your qualified Classé dealer.

- 3 **One speaker or subwoofer seems not to be playing.**
  - ✓ If the problem occurs with all inputs, check the interconnecting cables between the preamp and the power amp. Also check the speaker wires for secure connections.
  - ✓ Check the balance control setting by pressing MENU on the front panel, and then verify the balance control setting is not turning one channel off or reducing its output.
  - ✓ If the problem occurs for a subwoofer, make sure it is active on the configuration assigned to this source button.
  - ✓ Check the interconnect cables between the source component and the CP-800.
  
- 4 **The IR remote control does not seem to function.**
  - ✓ Ensure that there are no obstacles between the IR remote and the IR sensor, located to the right of the **Mute** button.
  - ✓ Replace the batteries in the remote control.
  
- 5 **There is a hum coming out of the speakers.**
  - ✓ If you are using single-ended interconnects, make sure they are not placed alongside any AC power cords. Also make sure that they are not too long – long single-ended interconnecting cables have a natural tendency to pick up noise even when shielded.
  - ✓ If any source components are connected to cable TV, try disconnecting the cable television line from the source component. If the hum goes away, you need an isolation device between your cable TV converter and the source component. Your Classé dealer can help you obtain one of these inexpensive devices.

## Care & Maintenance

To remove dust from the cabinet of your CP-800, use a feather duster or a lint-free soft cloth. To remove dirt and fingerprints, we recommend isopropyl alcohol and a soft cloth.

Dampen the cloth with alcohol first and then lightly clean the surface of the CP-800 with the cloth. Do not use excessive amounts of alcohol that might drip off the cloth and into the Surround Sound Processor.



**Caution!**

---

**Power down and remove the AC power cord from the CP-800 before performing maintenance. At no time should liquid cleaners be applied directly to the unit, as direct application of liquids may result in damage to electronic components within the unit.**

---

# Specifications

All specifications are accurate at the time of printing. Classé reserves the right to make improvements without notice.

- **Frequency response** 8 Hz - 200 kHz < 1 dB, stereo analog bypass  
8 Hz - 20kHz < 0.5 dB, all other sources
- **Channel Matching** (*Left to Right*) better than 0.05 dB
- **Distortion** (*THD+noise*) 0.0005%, digital source/bypassed analog source  
.002%, processed analog source
- **Maximum input level** (*single-ended*) 2 Vrms (DSP), 4.5Vrms (bypass)
- **Maximum input level** (*balanced*) 4 Vrms (DSP), 9 Vrms (bypass)
- **Maximum output level** (*single-ended*) 9 Vrms
- **Maximum output level** (*balanced*) 18 Vrms
- **Gain Range** -93 dB to +14 dB
- **Input impedance** (*single-ended*) 100 k $\Omega$  (single-ended)
- **Input impedance** (*balanced*) 50 k $\Omega$  (Balanced)
- **Output impedance** (*single-ended*) 100  $\Omega$
- **Output impedance** (*balanced*) 300  $\Omega$
- **Signal-to-noise ratio** (*ref. 4Vrms input, unweighted*)  
104 dB, bypassed analog source  
101 dB, processed analog source  
(*re. full-scale input, unweighted*) 105 dB, digital source
- **Channel separation** better than 100 dB
- **Channel matching** (*left to right*) >0.05 dB
- **Crosstalk** (*any input to any output*) better than -130 dB @ 1 kHz
- **Standby power consumption** <1 W
- **Rated power consumption** 31W
- **Mains voltage** 90-264 V, 50/60 Hz
- **Overall dimensions** Width: 17.5" (445mm)  
Depth (excluding connectors): 17.5" (445mm)  
Height: 4.78" (121mm)
- **Net weight** 23 lbs (10.43 kg)
- **Shipping weight** 33 lbs (15 kg)

# Continued

## Made for:

- iPod touch (4th generation)
- iPod touch (3rd generation)
- iPod touch (2nd generation)
- iPod touch (1st generation)
- iPod classic
- iPod nano (6th generation)
- iPod nano (5th generation)
- iPod nano (4th generation)
- iPod nano (3rd generation)
- iPod nano (2nd generation)

## Made for:

- iPhone 4
- iPhone 3GS
- iPhone 3G
- iPhone

## Made for iPad

Classé and the Classé logo are trademarks of Classé Audio Inc. of Lachine, Canada. All rights reserved.  
AMX is a registered trademark of AMX Corporation of Richardson, TX. All rights reserved.  
Crestron™ is a trademark of Crestron Electronics, Inc. of Rockleigh, NJ. All rights reserved.  
Control 4™ is a trademark of Control 4 Corporation of Saltlake City UT. All rights reserved.

“Made for iPod,” “Made for iPhone,” and “Made for iPad” mean that an electronic accessory has been designed to connect specifically to iPod, iPhone, or iPad, respectively, and has been certified by the developer to meet Apple performance standards. Apple is not responsible for the operation of this device or its compliance with safety and regulatory standards. Please note that the use of this accessory with iPod, iPhone, or iPad may affect wireless performance.

iPhone, iPod, iPod classic, iPod nano, and iPod touch are trademarks of Apple Inc., registered in the U.S. and other countries. iPad is a trademark of Apple Inc.

# Dimensions

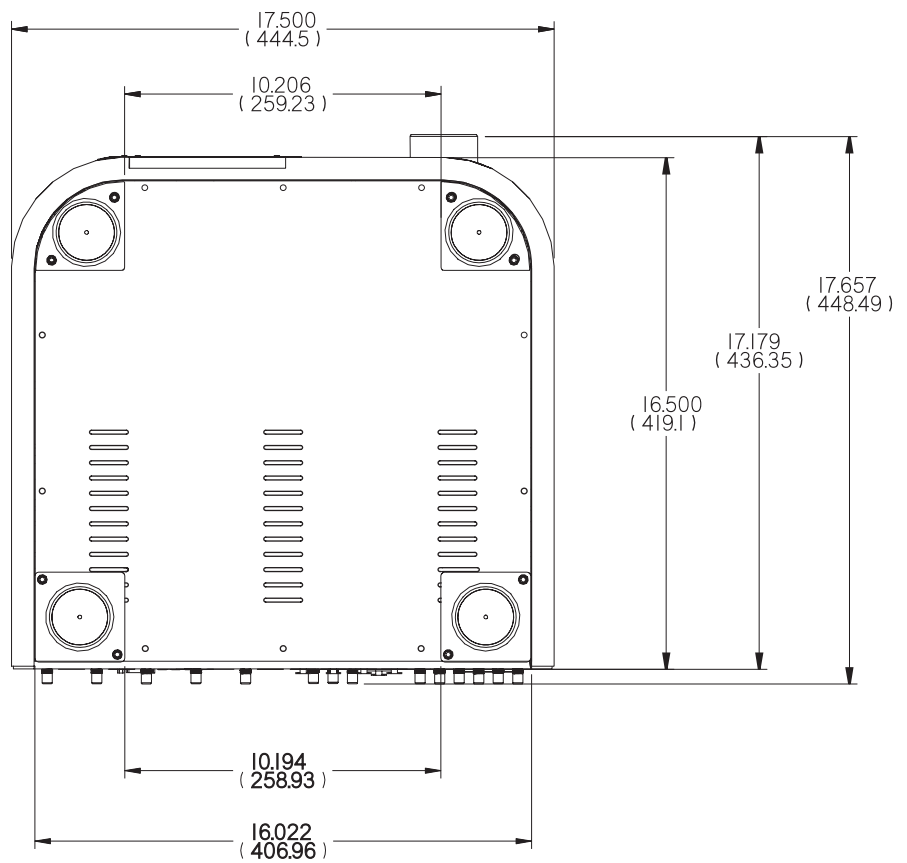
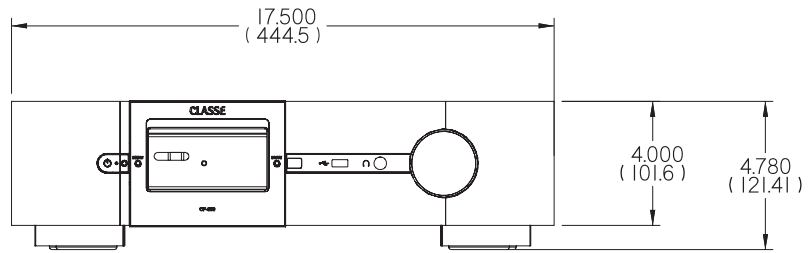

# Installation Worksheet

**Source:** \_\_\_\_\_

Audio Connector: \_\_\_\_\_

Input: \_\_\_\_\_

**Source:** \_\_\_\_\_

Audio Connector: \_\_\_\_\_

Input: \_\_\_\_\_

**Source:** \_\_\_\_\_

Audio Connector: \_\_\_\_\_

Input: \_\_\_\_\_

**Source:** \_\_\_\_\_

Audio Connector: \_\_\_\_\_

Input: \_\_\_\_\_

**Source:** \_\_\_\_\_

Audio Connector: \_\_\_\_\_

Input: \_\_\_\_\_

**Source:** \_\_\_\_\_

Audio Connector: \_\_\_\_\_

Input: \_\_\_\_\_

**Source:** \_\_\_\_\_

Audio Connector: \_\_\_\_\_

Input: \_\_\_\_\_



# CLASSE

## **Classé Audio**

5070 François Cusson  
Lachine, Quebec  
Canada H8T 1B3

+1 (514) 636-6384  
+1 (514) 636-1428 (fax)

<http://www.classeaudio.com>

email: [cservice@classeaudio.com](mailto:cservice@classeaudio.com)

North America: 1 800 370 3740  
email: [classe@bwgroupusa.com](mailto:classe@bwgroupusa.com)

Europe: 44 (0) 1903 221 700  
email: [classe@bwgroup.com](mailto:classe@bwgroup.com)

Asia: (852) 2790 8903  
email: [classe@bwgroup.hk](mailto:classe@bwgroup.hk)

All Others: +1 514 636 6384  
email: [cservice@classeaudio.com](mailto:cservice@classeaudio.com)